

| REVISION HISTORY | | | | |
|------------------|---|-----------|--------|------------|
| REV. | DESCRIPTION | DATE | ECO | BY |
| D | UPDATED BOM | 3/26/2014 | | RCOLBOCH |
| E | UPDATED TITLE BLOCK | 6/18/2014 | | JBOSSERDET |
| F | UPDATED TAG DATA TO INCLUDE COPING LENGTHS. | 1/26/2015 | 391702 | JBOSSERDET |

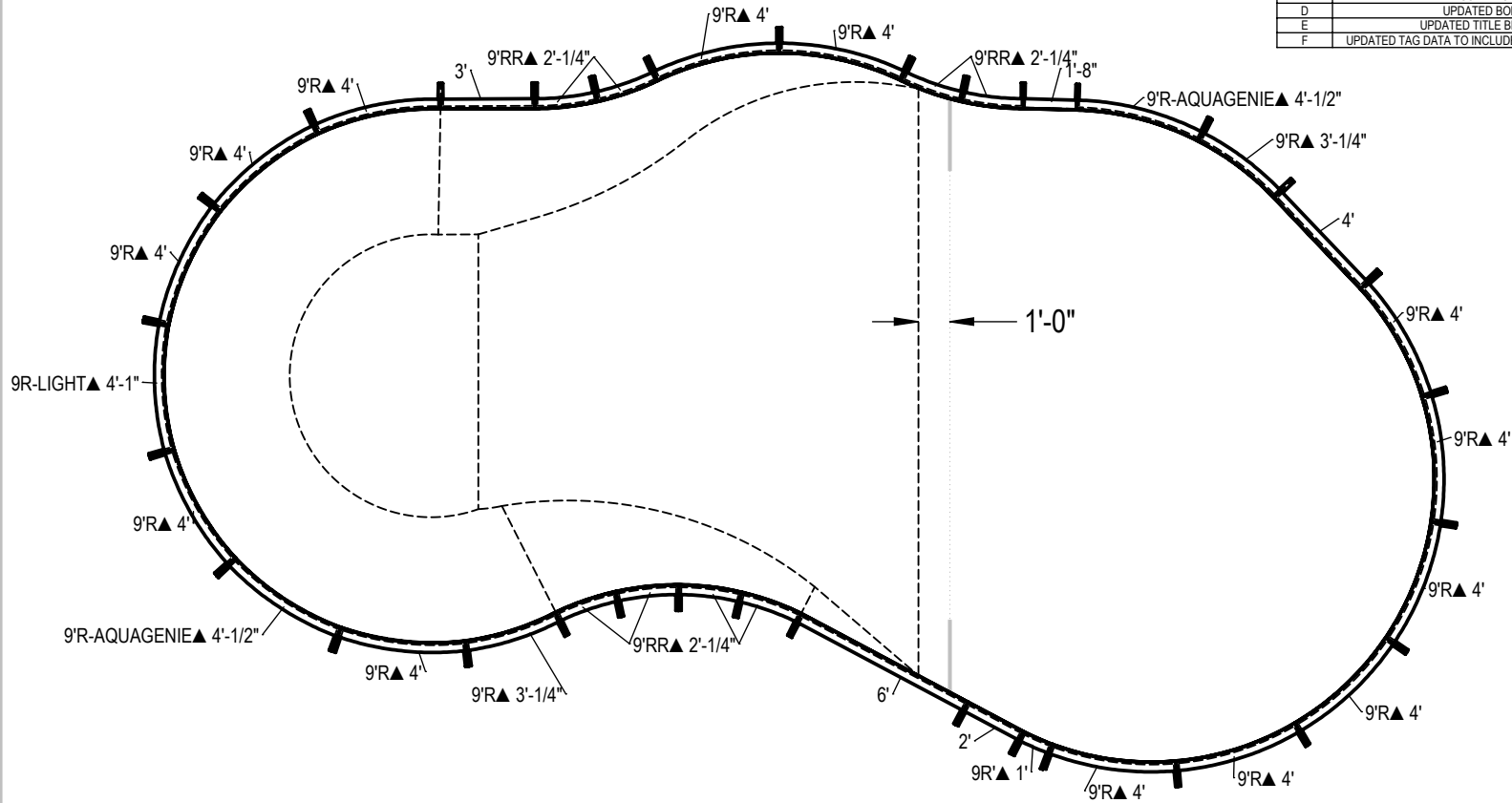

NOTES:

1. THESE ARE FINISHED DIMENSIONS READY FOR THE LINER.
2. DIMENSIONS ARE FROM INSIDE POOL PANELS.
3. THE IDEAL WATER LEVEL SHOULD BE TO THE MIDDLE OF THE SKIMMER OPENING(S).

EXCAVATION NOTES:

4. ROUGH EXCAVATION SHOULD BE 2" DEEPER IN EACH INSTANCE.
5. SOIL TO HAVE MINIMUM BEARING CAPACITY OF 1500 PSF.
6. LOCATE TOP OF POOL AT LEAST 6" ABOVE THE SURROUNDING LAND ELEVATION.
7. SEE "OVER DIG DETAIL" FOR EXCAVATION AROUND POOL.
8. FILL VOIDS UNDER BASE OF PANELS AND TAMP WELL.
9. BACK FILL WITH NON-EXPANSIVE MATERIAL.
10. ANSI / APSP / ICC-5 FOR RESIDENTIAL POOLS, 2003-2007 BOCA CODE SECTION 421.

IMPORTANT NOTES:

11. THIS DOCUMENT IS FOR ILLUSTRATIVE PURPOSES ONLY. THE DEALER OR CONTRACTOR WHO SELLS OR INSTALLS YOUR POOL IS AN INDEPENDENT CONTRACTOR AND IS NOT AN AGENT OF THE MANUFACTURER. THE CONSTRUCTION METHODS ILLUSTRATED HERE ARE SUGGESTIONS AND APPLY ONLY TO NORMAL GROUND CONDITIONS. THERE MAY BE ADDITIONAL PRECAUTIONS AND/OR METHODS OF CONSTRUCTION. PROPER INSTALLATION IS THE RESPONSIBILITY OF THE DEALER/BUILDER/CONTRACTOR.

| ITEM | FILE NAME | DESCRIPTION | CUSTOMER DRAWING # | VENDOR PART # | QTY. | VENDOR NAME | MATERIAL |
|------|----------------------------------|---|--------------------|---------------|------|-------------|----------|
| 1 | BRACE | BRACE, 4 TAB, HYDRA - 100 SERIES | HP199 | HP199 | 32 | HYDRA POOLS | PS |
| 2 | PANEL, 1'-8 IN LONG | PANEL, 1'-8" LONG - 100 SERIES | HP116 | HP116 | 1 | HYDRA POOLS | PS |
| 3 | PANEL, 2' LONG | PANEL, 2' LONG - 100 SERIES | HP102 | HP102 | 1 | HYDRA POOLS | PS |
| 4 | PANEL, 3' LONG | PANEL, 3' LONG - 100 SERIES | HP103 | HP103 | 1 | HYDRA POOLS | PS |
| 5 | PANEL, 4' LONG | PANEL, 4' LONG - 100 SERIES | HP104 | HP104 | 1 | HYDRA POOLS | PS |
| 6 | PANEL, 6' LONG | PANEL, 6' LONG - 100 SERIES | HP106 | HP106 | 1 | HYDRA POOLS | PS |
| 7 | PANEL, 9' RADIUS WITH AQUA GENIE | PANEL, 9' RADIUS WITH AQUAGENIE - 100 SERIES | HP159A | HP159A | 2 | HYDRA POOLS | PS |
| 8 | PANEL, 9' RADIUS WITH LIGHT | PANEL, 9' RADIUS WITH LIGHT - 100 SERIES | HP159LL | HP159LL | 1 | HYDRA POOLS | PS |
| 9 | PANEL, 9' RADIUS, 1' LONG | PANEL, 9' RADIUS, 1' LONG - 100 SERIES | HP115 | HP115 | 1 | HYDRA POOLS | PS |
| 10 | PANEL, 9' RADIUS, 3' LONG | PANEL, 9' RADIUS, 3' LONG, ROMAN - 100 SERIES | HP125 | HP125 | 2 | HYDRA POOLS | PS |
| 11 | PANEL, 9' RADIUS, 4' LONG | PANEL, 9' RADIUS, 4' LONG - 100 SERIES | HP159 | HP159 | 13 | HYDRA POOLS | PS |
| 12 | PANEL, 9' REVERSE RADIUS | PANEL, 9' REVERSE RADIUS - 100 SERIES | HP119N | HP119N | 8 | HYDRA POOLS | PS |

| | | | | | |
|--|------------------------|--|--------------------|----------------|--|
| ENGINEERING DRAWING NUMBER: 00005029 | WEIGHT: | UNLESS OTHERWISE SPECIFIED DIMENSIONS ARE IN INCHES TOLERANCES DECIMALS: X ± .1 XX ± .01 XXX ± .001 XXXX ± .0005 | DESIGNED BY: | CREATION DATE: | HYDRA POOLS |
| | lbs | | RCOLBOCH | 1/7/2014 | |
| | VOLUME: | | DETAILED BY: | DETAILED DATE: | |
| | Inch ³ | | JBOSSERDET | 10/5/2012 | |
| COLOR: | ANGULAR: X ± 0.5 | LAST REVISED BY: | LAST REVISED DATE: | TITLE: | LAYOUT, 22'-7" x 40'-5", MIRAGE, 8' DEEP, 100 SERIES |
| NA | THIRD ANGLE PROJECTION | Jbosserdet | 1/26/2015 | PART NUMBER: | |
| HEAT TREAT: | | MATERIAL: | | | |
| NA | | | | | |
| FINISH: | | | | | |
| NA | | | | | |
| TEXTURE: | | | | | |
| NA | | | | | |

PART NUMBER: **10916**

SCALE: 1:192
SHEET: 1 OF 6
SIZE: **A**

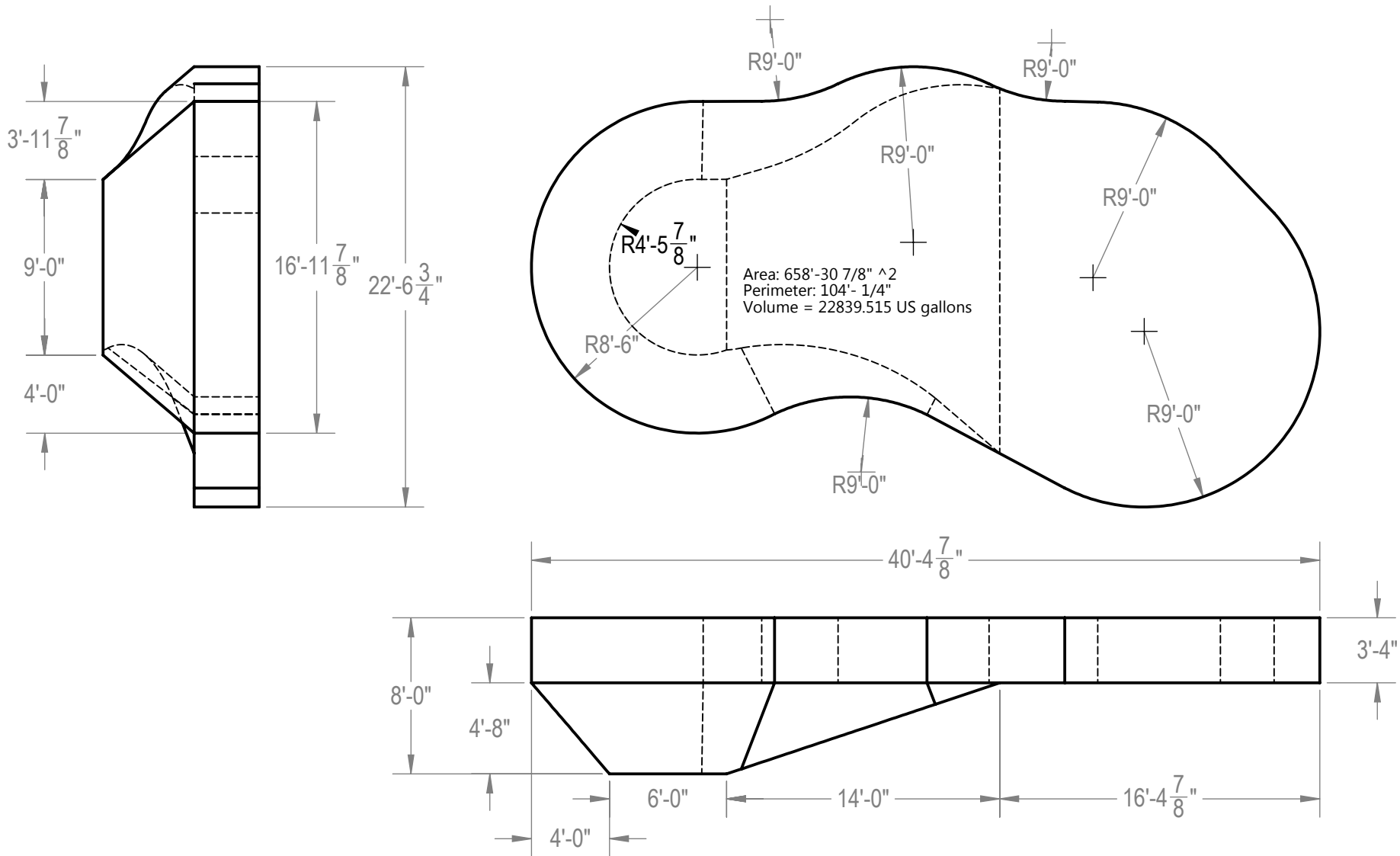

NOTES:

1. THESE ARE FINISHED DIMENSIONS READY FOR THE LINER.
2. DIMENSIONS ARE FROM INSIDE POOL PANELS.
3. THE IDEAL WATER LEVEL SHOULD BE TO THE MIDDLE OF THE SKIMMER OPENING(S).

EXCAVATION NOTES:

4. ROUGH EXCAVATION SHOULD BE 2" DEEPER IN EACH INSTANCE.
5. SOIL TO HAVE MINIMUM BEARING CAPACITY OF 1500 PSF.
6. LOCATE TOP OF POOL AT LEAST 6" ABOVE THE SURROUNDING LAND ELEVATION.
7. SEE "OVER DIG DETAIL" FOR EXCAVATION AROUND POOL.
8. FILL VOIDS UNDER BASE OF PANELS AND TAMP WELL.
9. BACK FILL WITH NON-EXPANSIVE MATERIAL.
10. ANSI / APSP / ICC-5 FOR RESIDENTIAL POOLS, 2003-2007 BOCA CODE SECTION 421.

IMPORTANT NOTES:

11. THIS DOCUMENT IS FOR ILLUSTRATIVE PURPOSES ONLY. THE DEALER OR CONTRACTOR WHO SELLS OR INSTALLS YOUR POOL IS AN INDEPENDENT CONTRACTOR AND IS NOT AN AGENT OF THE MANUFACTURER. THE CONSTRUCTION METHODS ILLUSTRATED HERE ARE SUGGESTIONS AND APPLY ONLY TO NORMAL GROUND CONDITIONS. THERE MAY BE ADDITIONAL PRECAUTIONS AND/OR METHODS OF CONSTRUCTION. PROPER INSTALLATION IS THE RESPONSIBILITY OF THE DEALER/BUILDER/CONTRACTOR.

| | | | | | |
|--|-------------------|---|--------------------|----------------|--|
| ENGINEERING DRAWING NUMBER: 00005029 | WEIGHT: | UNLESS OTHERWISE SPECIFIED DIMENSIONS ARE IN INCHES TOLERANCES DECIMALS: X ± .1 XX ± .01 XXX ± .001 XXXX ± .0005 ANGULAR: X ± 0.5 THIRD ANGLE PROJECTION | DESIGNED BY: | CREATION DATE: | HYDRA POOLS |
| | lbs | | RCOLBOCH | 1/7/2014 | |
| | VOLUME: | | | DETAILED BY: | DETAILED DATE: |
| | Inch ³ | | | JBOSSERDET | 10/5/2012 |
| COLOR: | | LAST REVISED BY: | LAST REVISED DATE: | TITLE: | LAYOUT, 22'-7" x 40'-5", MIRAGE, 8' DEEP, 100 SERIES |
| NA | | Jbosserdet | 1/26/2015 | PART NUMBER: | 10916 |
| HEAT TREAT: | | MATERIAL: | | SCALE: | 1:192 |
| NA | | | | SHEET: | 2 OF 6 |
| FINISH: | | | | SIZE: | A |
| NA | | | | | |
| TEXTURE: | | | | | |
| NA | | | | | |

| | |
|------|-------------|
| A-S1 | 27'-3 5/8" |
| B-S1 | 19'-10 1/8" |
| A-S2 | 35'-4" |
| B-S2 | 29'-11 3/8" |
| A-S3 | 21'-9 5/8" |
| B-S3 | 37'-8 5/8" |
| A-S4 | 15'-8 1/8" |
| B-S4 | 34'-6 1/2" |

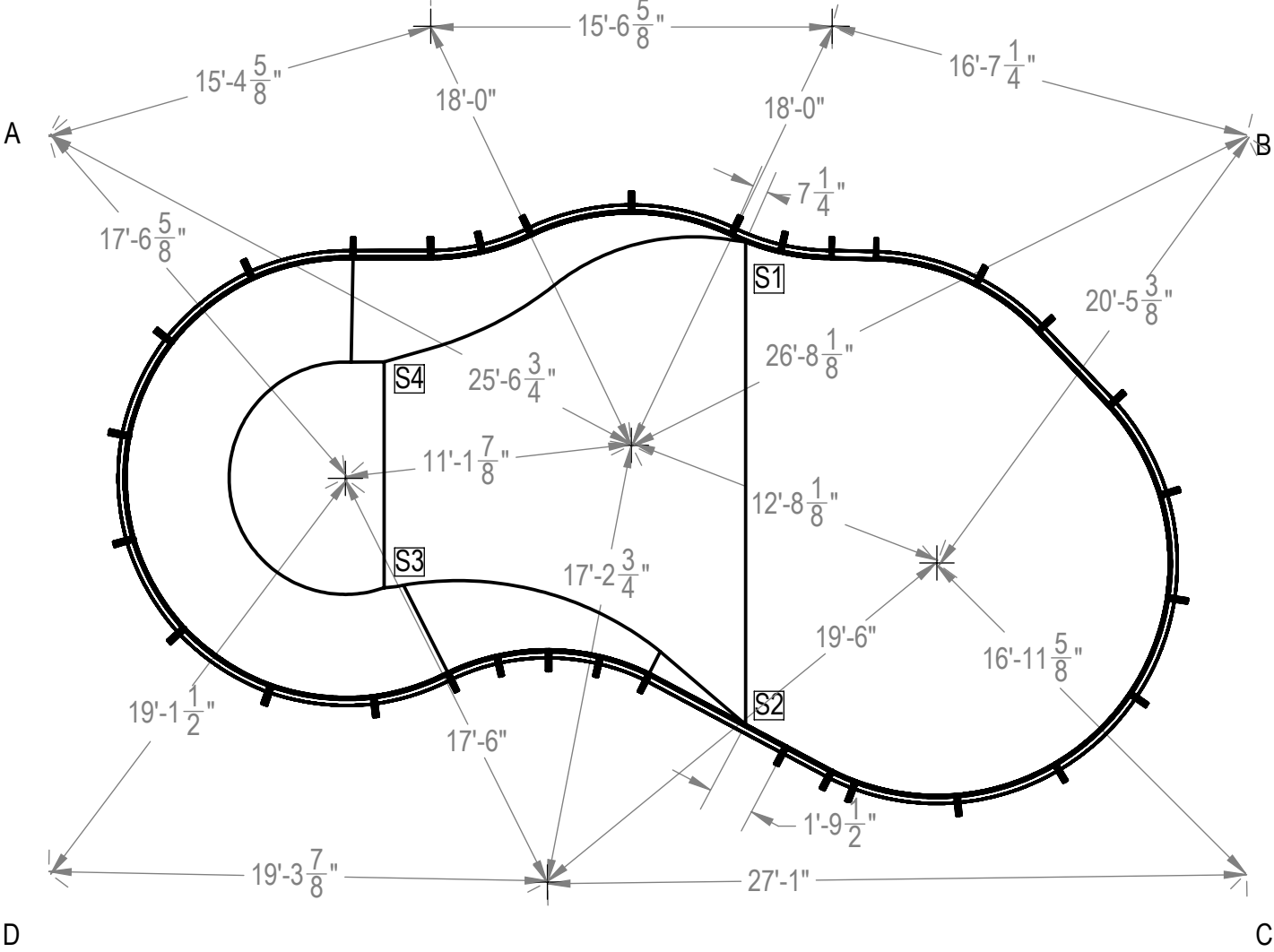

| | | | | | |
|--|-------------------|---|------------------|--------------------|--|
| ENGINEERING DRAWING NUMBER: 00005029 | WEIGHT: | UNLESS OTHERWISE SPECIFIED DIMENSIONS ARE IN INCHES TOLERANCES DECIMALS: X ± 0.1 XX ± 0.01 XXX ± 0.005 XXXX ± 0.0005 ANGULAR: X ± 0.5 THIRD ANGLE PROJECTION  | DESIGNED BY: | CREATION DATE: | HYDRA POOLS LAYOUT, 22'-7" x 40'-5", MIRAGE, 8' DEEP, 100 SERIES |
| | lbs | | RCOLBOCH | 1/7/2014 | |
| | VOLUME: | | DETAILED BY: | DETAILED DATE: | |
| | Inch ³ | | JBOSSERDET | 10/5/2012 | |
| | COLOR: | | LAST REVISED BY: | LAST REVISED DATE: | |
| NA | jbosserdet | 1/26/2015 | TITLE: | | |
| HEAT TREAT: | MATERIAL: | | PART NUMBER: | SCALE: | SIZE: |
| NA | | | 10916 | 1:192 | A |
| FINISH: | | | | SHEET: | |
| NA | | | | 3 OF 6 | |
| TEXTURE: | | | | | |
| NA | | | | | |

| | A | B | C | D |
|----|-------------|-------------|-------------|-------------|
| 1 | 12'- 3/4" | 44'-9 1/2" | 46'-5 1/4" | 17'-2 1/2" |
| 2 | 9'-4 1/4" | 42'-4 1/2" | 46'-4 5/8" | 21'- 7/8" |
| 3 | 9'-8" | 38'-10 3/4" | 44'-10 1/8" | 24'-3 3/4" |
| 4 | 12'-8 5/8" | 34'-11 1/4" | 41'-11 7/8" | 26'-6 1/2" |
| 5 | 15'-6 3/8" | 31'-11 5/8" | 39'-6 3/4" | 28'- 1/8" |
| 6 | 17'-4 3/4" | 29'-11 3/8" | 38'-1 1/2" | 29'-3 5/8" |
| 7 | 19'-1 1/8" | 27'-11 5/8" | 37'-1 1/4" | 30'-11 5/8" |
| 8 | 22'-9 1/8" | 24'- 1/4" | 34'-11 3/8" | 34'-1 1/8" |
| 9 | 26'-8 5/8" | 20'-4" | 31'-8 7/8" | 36'-2 1/8" |
| 10 | 28'-8 1/2" | 18'-7 3/8" | 30'- 5/8" | 37'-1 7/8" |
| 11 | 30'-8 5/8" | 16'-8 7/8" | 28'-8 1/2" | 38'-6 3/4" |
| 12 | 32'-4 3/8" | 15'-2" | 27'-9 1/4" | 39'-10 1/4" |
| 13 | 36'-4 1/4" | 12'-0" | 25'- 3/4" | 42'-6" |
| 14 | 39'- 1/2" | 11'-1 3/8" | 22'-5 5/8" | 43'-7 7/8" |
| 15 | 42'-4 1/2" | 11'-9 3/8" | 18'-10" | 44'-10 1/8" |
| 16 | 45'-2 5/8" | 14'-4 1/4" | 15'-0" | 45'-5 1/8" |
| 17 | 46'-10 1/4" | 18'-2 1/8" | 11'-1 1/8" | 44'-7" |
| 18 | 47'-1 1/8" | 22'- 7/8" | 8'-3 3/4" | 42'-5 1/8" |
| 19 | 45'-11 1/8" | 25'-5 1/8" | 8'-6 3/4" | 39'-2 1/4" |
| 20 | 43'-5 5/8" | 27'-10 5/8" | 11'-7 3/8" | 35'-3 3/4" |
| 21 | 40'- 1/8" | 29'-2 3/4" | 15'-6 3/4" | 31'-5 3/8" |
| 22 | 39'- 1/2" | 29'-4 1/2" | 16'-6 5/8" | 30'-7" |
| 23 | 37'-1 1/8" | 29'-7 3/8" | 18'-5 7/8" | 28'-11 7/8" |
| 24 | 31'-2 5/8" | 31'-1 5/8" | 24'-4 3/4" | 24'-6 1/8" |
| 25 | 29'-4 1/2" | 32'-1 5/8" | 26'-4 7/8" | 22'-11 1/2" |
| 26 | 27'-9 3/8" | 33'-7" | 28'-4 5/8" | 21'-2 3/8" |
| 27 | 26'-7" | 35'-4" | 30'-2 7/8" | 19'-3 1/2" |
| 28 | 25'-10 7/8" | 37'-3 3/8" | 31'-10 7/8" | 17'-3 1/2" |
| 29 | 25'-1" | 40'-2 1/4" | 34'-6 1/8" | 14'-3 7/8" |
| 30 | 22'-11 3/8" | 43'-4 3/8" | 38'-5 3/4" | 11'-3 3/8" |
| 31 | 19'-9 3/8" | 45'-4" | 42'-2 1/2" | 10'-10 1/4" |
| 32 | 15'-11 1/2" | 45'-9 7/8" | 44'-11 7/8" | 13'-4 3/8" |

| | |
|-----|------------|
| A-B | 46'-4 3/4" |
| B-C | 28'-6 3/4" |
| A-C | 54'-5 3/4" |

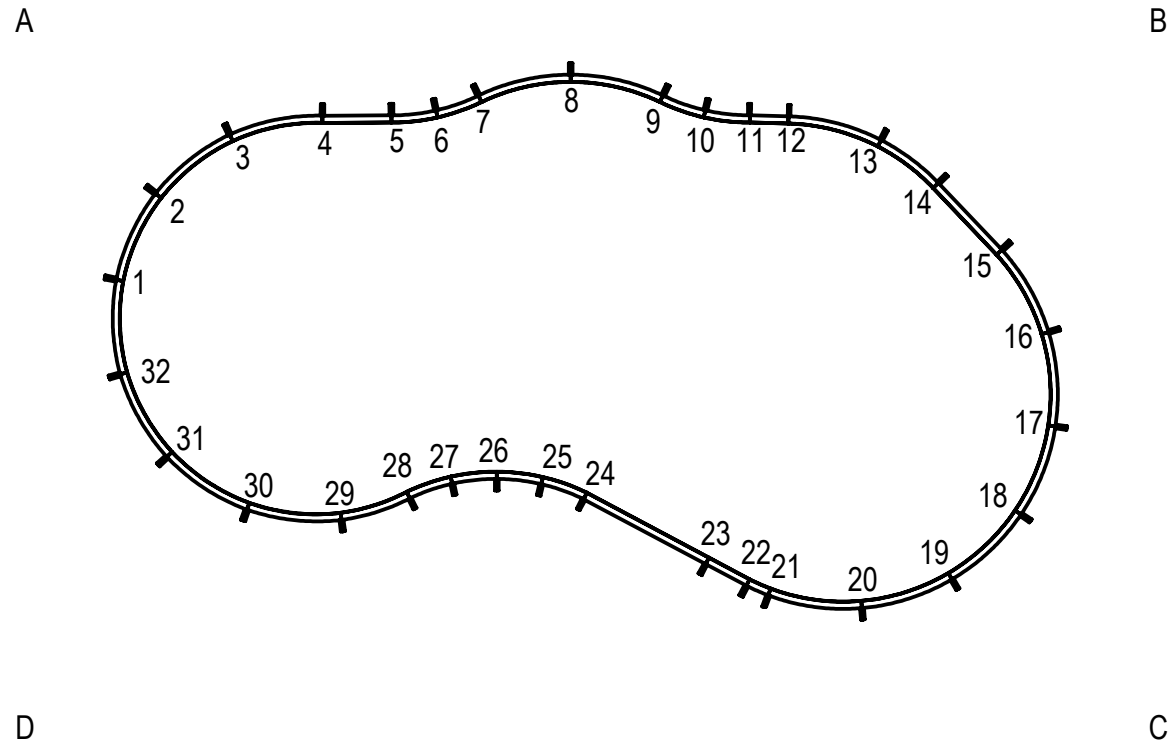

| | | | | | | |
|---|-------------------|---|------------------|--------------------|---|----------|
| ENGINEERING DRAWING NUMBER 00005029 | WEIGHT: | UNLESS OTHERWISE SPECIFIED DIMENSIONS ARE IN INCHES TOLERANCES DECIMALS: X ± 0.1 XX ± 0.01 XXX ± 0.005 XXXX ± 0.0005 ANGULAR: X ± 0.5 THIRD ANGLE PROJECTION | DESIGNED BY: | CREATION DATE: | HYDRA POOLS TITLE: LAYOUT, 22'-7" x 40'-5", MIRAGE, 8' DEEP, 100 SERIES | |
| | lbs | | RCOLBOCH | 1/7/2014 | | |
| | VOLUME: | | DETAILED BY: | DETAILED DATE: | | |
| | Inch ³ | | JBOSSERDET | 10/5/2012 | | |
| | COLOR: | | LAST REVISED BY: | LAST REVISED DATE: | | |
| NA | jbossdet | 1/26/2015 | PART NUMBER: | 10916 | SCALE: | SIZE: |
| HEAT TREAT: | MATERIAL: | | | | 1:192 | A |
| NA | | | | | 4 OF 6 | |
| FINISH: | | | | | | |
| NA | | | | | | |
| TEXTURE: | | | | | | |
| NA | | | | | | |

A
13'-1 ³/₄"

15'-5"

D

B

C

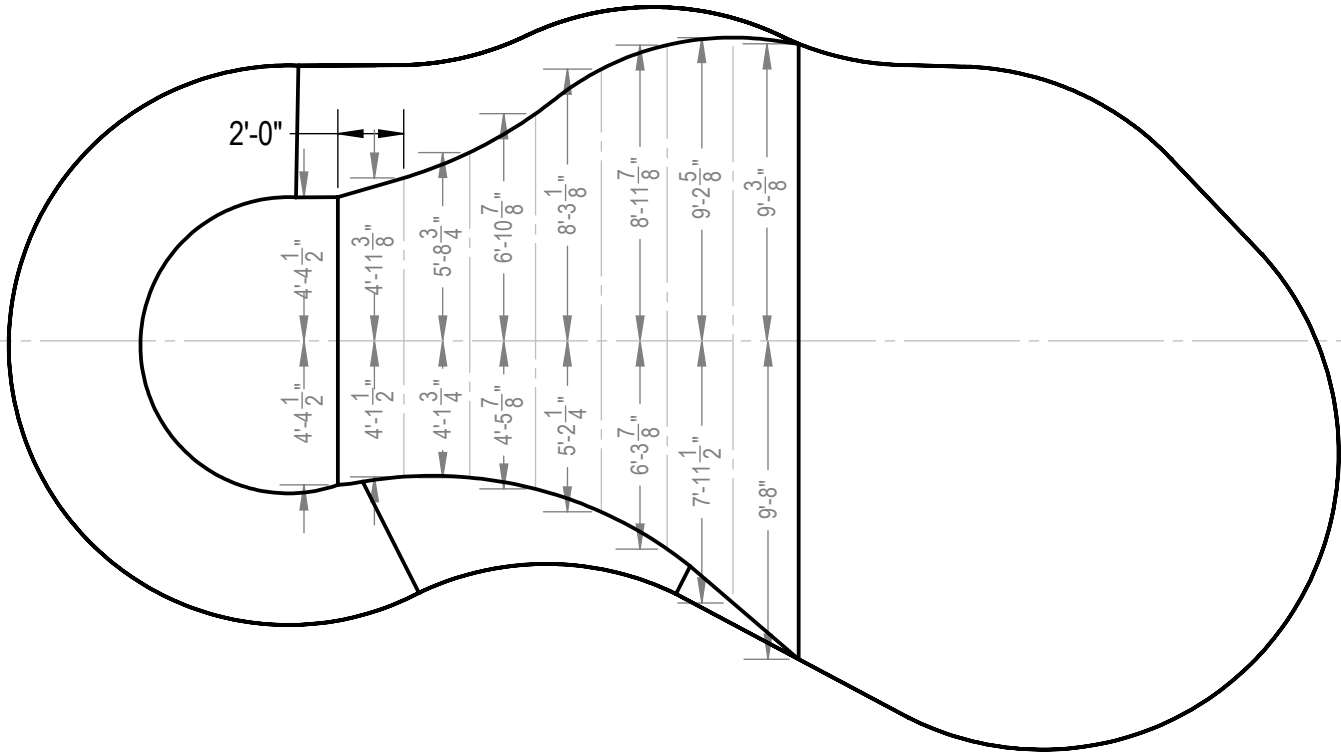

| | | | | | | |
|--|-------------------|---|------------------|--------------------|--------------------|--|
| ENGINEERING DRAWING NUMBER: 00005029 | WEIGHT: | UNLESS OTHERWISE SPECIFIED DIMENSIONS ARE IN INCHES TOLERANCES DECIMALS: X ± 0.1 XX ± 0.01 XXX ± 0.005 XXXX ± 0.0005 ANGULAR: X ± 0.5 THIRD ANGLE PROJECTION  | DESIGNED BY: | CREATION DATE: | HYDRA POOLS | |
| | lbs | | RCOLBOCH | 1/7/2014 | | |
| | VOLUME: | | DETAILED BY: | DETAILED DATE: | | |
| | Inch ³ | | JBOSSERDET | 10/5/2012 | TITLE: | LAYOUT, 22'-7" x 40'-5', MIRAGE, 8' DEEP, 100 SERIES |
| | COLOR: | | LAST REVISED BY: | LAST REVISED DATE: | PART NUMBER: | |
| | NA | | jbossdet | 1/26/2015 | 10916 | SCALE: |
| HEAT TREAT: | MATERIAL: | | | 1:192 | A | |
| NA | | | | SHEET: | | |
| FINISH: | | | | 5 OF 6 | | |
| TEXTURE: | | | | | | |
| NA | | | | | | |

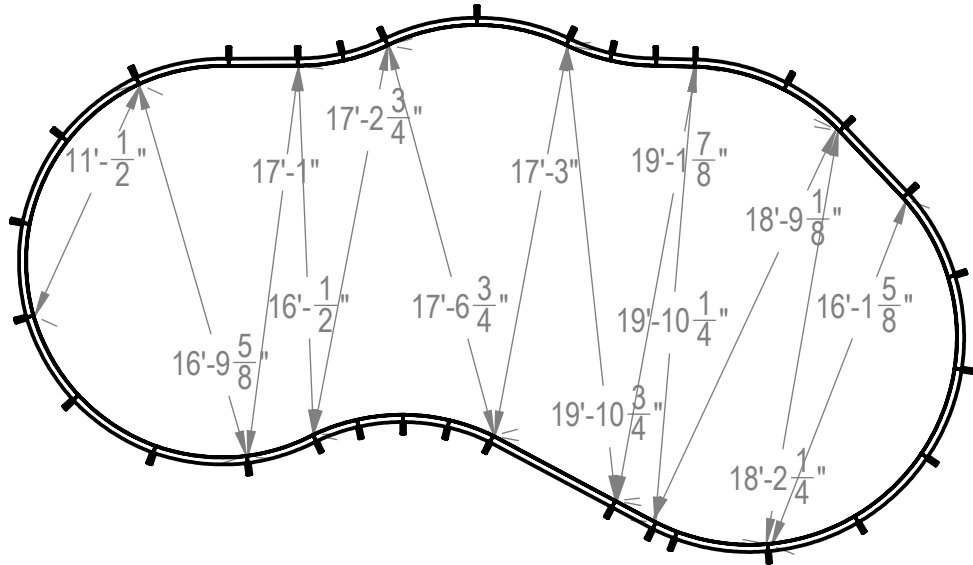
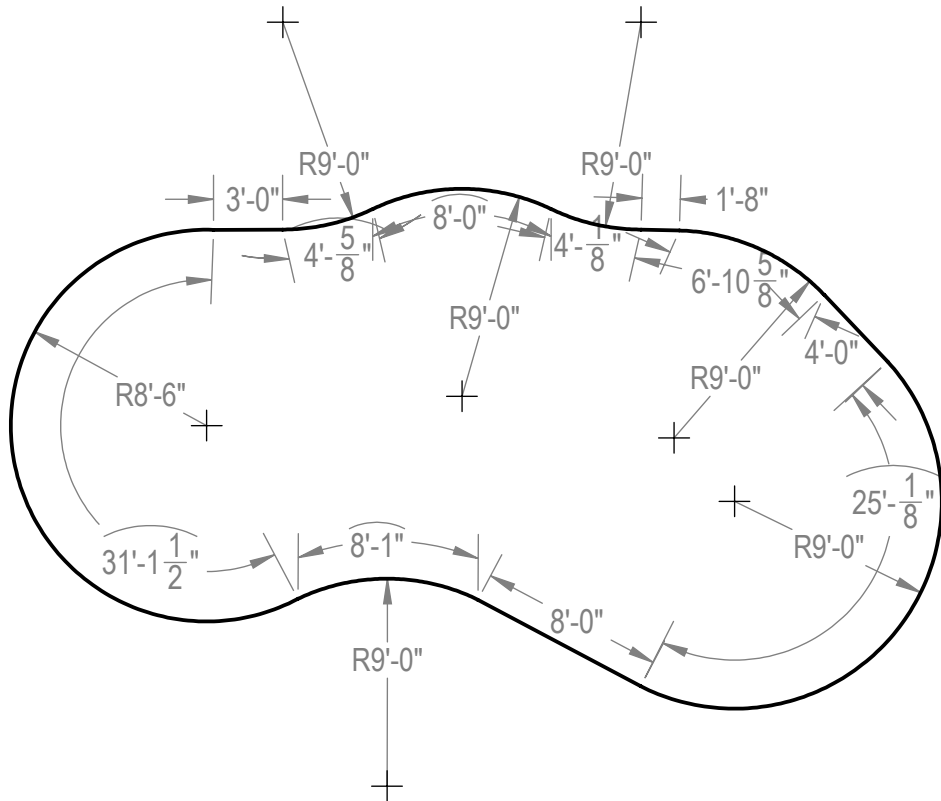

| | | | | | | | | | | |
|--|-------------------|---|--------------|------------------|--------------------|--|--|------------------------------|--------|-------|
| ENGINEERING DRAWING NUMBER: 00005029 | WEIGHT: | UNLESS OTHERWISE SPECIFIED DIMENSIONS ARE IN INCHES TOLERANCES DECIMALS: X ± 0.1 XX ± 0.01 XXX ± 0.005 XXXX ± 0.0005 ANGULAR: X ± 0.5 THIRD ANGLE PROJECTION | DESIGNED BY: | CREATION DATE: | HYDRA POOLS | | | | | |
| | lbs | | RCOLBOCH | 1/7/2014 | | | | | | |
| | VOLUME: | | MATERIAL: | DETAILED BY: | DETAILED DATE: | TITLE: LAYOUT, 22'-7" x 40'-5", MIRAGE, 8' DEEP, 100 SERIES | | | | |
| | Inch ³ | | | JBOSSERDET | 10/5/2012 | | | | | |
| | COLOR: | | | LAST REVISED BY: | LAST REVISED DATE: | | | PART NUMBER: 10916 | SCALE: | SIZE: |
| | NA | | | jbosserdet | 1/26/2015 | | | | 1:192 | A |
| HEAT TREAT: | | | | SHEET: | | | | | | |
| NA | | | | 6 OF 6 | | | | | | |
| FINISH: | | | | | | | | | | |
| NA | | | | | | | | | | |
| TEXTURE: | | | | | | | | | | |
| NA | | | | | | | | | | |